



WIFI Heating Element

Installation Guide

Contents

Intended use & Safety Information	Page 1
Installation Safety Information	Page 2
General Information	Page 2
Element Installation	Page - 3
Electrical Installation	Page 3
Connecting to WIFI	Page - 3
Element Panel & Operation	Page 4/5
App Interface & Settings	Page 5/6
Trouble Shooting	Page 7
Technical Information	Page 7
Your Guarantee	Page - 8
Aftercare	Page - 8
Recycling & Disposal	Page 8
Contact Us	Page - 8

Intended Use & safety Information

Please read carefully...

This product is intended for use in domestic or commercial environments such as homes, shops, hotels etc.

This product is not intended for use in a corrosive or explosive atmosphere (dust, vapor or gas)

This appliance can be used by children aged from 8 years and above and persons with reduced physical, sensory or mental capabilities or lack of experience and knowledge if they have been given supervision or instruction concerning use of the appliance in a safe way and understand the hazards involved. Children shall not play with the appliance. Cleaning and user maintenance shall not be made by children without supervision.

Children ages from 3 years and less than 8 years shall only switch on/off the appliance provided it is placed or installed in its intended normal operating position and they have been given supervision or instruction concerning use of the appliance in a safe way and understand the hazards involved.

Children aged from 3 years and less than 8 years shall not plug in, regulate and clean the appliance or perform user maintenance.

Children of less than 3 years should be kept away unless continuously supervised.

This product should be installed by a qualified installer in accordance with all applicable local regulations and connected to an electrical output in good condition.

Extension leads or plug adapters should not be used in order to supply power to this product.

The element cord cannot be replaced. If the cord is damaged the element should be removed and disposed of.

This product can be installed in zone 1- 3 or outside the zones when installing in a bathroom, all local regulations should be adhered to.

The use of this heater in zones 0 is totally prohibited, if unsure seek advice from a professional.

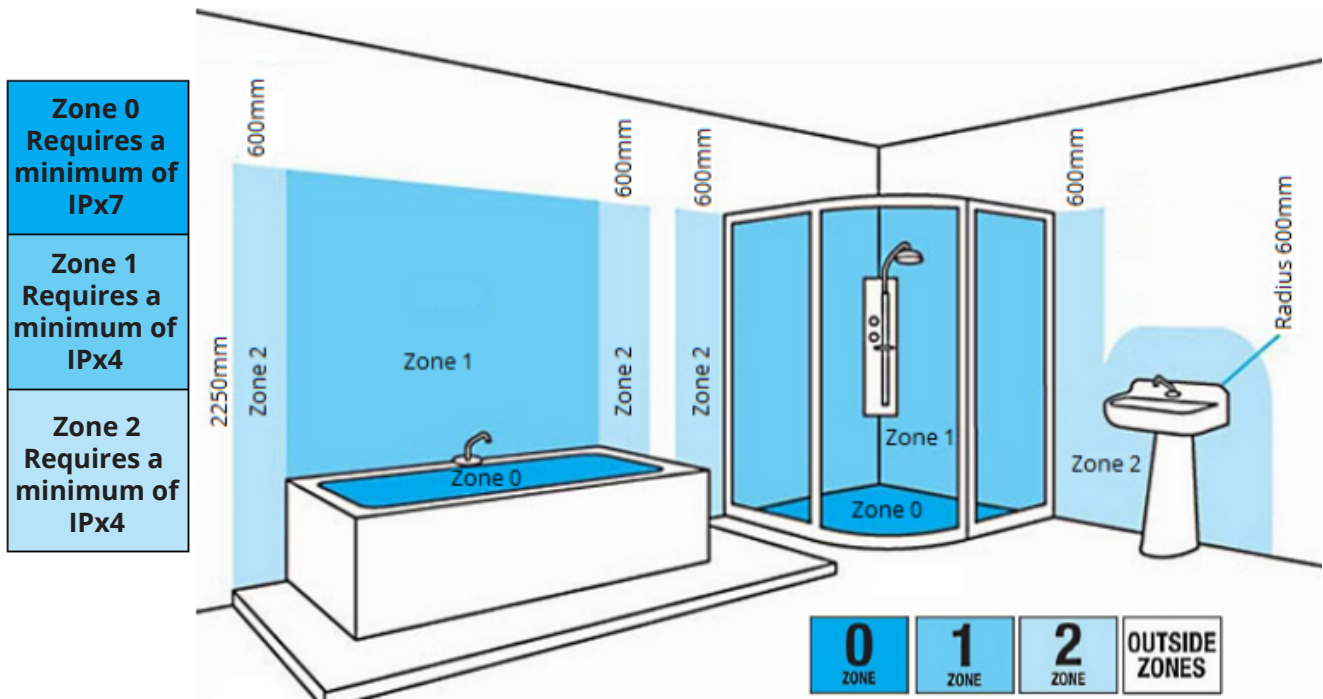

The heating element can be installed in bathrooms in zone 1, 2 and outside the zones as defined by applicable law, subject to any additional regulations concerning electrical installations in wet areas.

Installation Safety Information

Always disconnect the power before installing. If in any doubt contact a qualified or fully competent person.

If the element is purchased with a plug the product should only be connected to a power outlet in good condition.

Local electrical regulations must be adhered to with a permanent installation (cable connection without plug).

When connecting the element ensure that the circuit has a 30 mA residual-current circuit breaker and an appropriate over current circuit breaker.

With a permanent installation (cable connection without plug) it is also mandatory to have a cut-off device (fused spur) for disconnecting the device on all poles, by points of contact with the clearance of 3 mm.

Please pay attention to the safety zones if installing in a bathroom.

This product must not be located immediately below a socket outlet.

The element must NEVER be used without the towel rail or radiator being filled with water or fluid, It is imperative that you have the correct fluid level (90% fluid of towel rail or radiators total volume is recommended).

Only use the device in a suitable towel rail or radiator, for space heating and/or towel drying.

This element can be mounted vertically or horizontally but always in the BOTTOM inlet, never fit the element at the top of a radiator or towel rail.

General Information

Do not throw away packaging until you have located and confirmed that you have all included parts and the product is in good condition, keep all packaging away from children.

Check the device for damage before installation and on a regular basis. If any damaged is found on the element it should not be used, if any damage is caused once installed or during installation the device should be switched off and disconnected immediately.

Keep the element power cord away from any hot surfaces of the radiator. The element has no serviceable parts, never dismantle the element as this will invalidate the warranty and could lead to injury.

Warning! Never tighten using the housing itself, Always use the correct tools (Spanner).

Please read the full manual before installing. 

Tools required for installing:

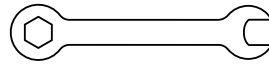

Installing The Heating Element

These are general-purpose instructions for fitting your element into a suitable radiator or towel rail. If purchasing the radiator or towel rail separately from the element always check with the radiator or towel rail manufacturer to ensure the product is suitable for use with the element selected and follow any additional installation guidance provided with the radiator or towel rail.

WARNING – Do not attempt to operate the element before it has been installed in a fluid-filled radiator or towel rail. Switching on the element in an empty radiator or in open air will cause the element to cease functioning. Always switch off the power supply at the mains during installation and maintenance. We recommend that the fuse is withdrawn or circuit breaker switched off at the distribution board while work is in progress.

Please refer to the Online Glycol fill level manual for filling instructions and further element installation advice

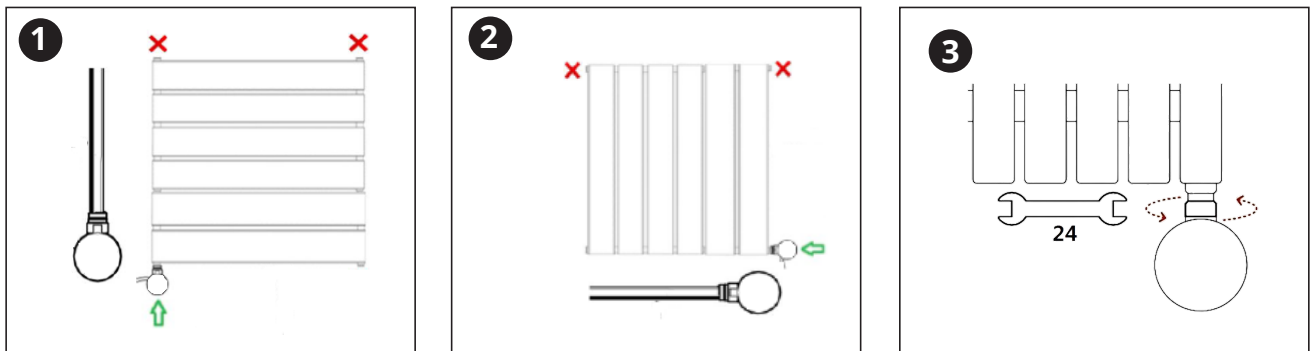

NOTE - Never attempt to tighten the element by twisting the control head or product housing. Always use the correct tools as directed in the instructions.

Electrical Installation

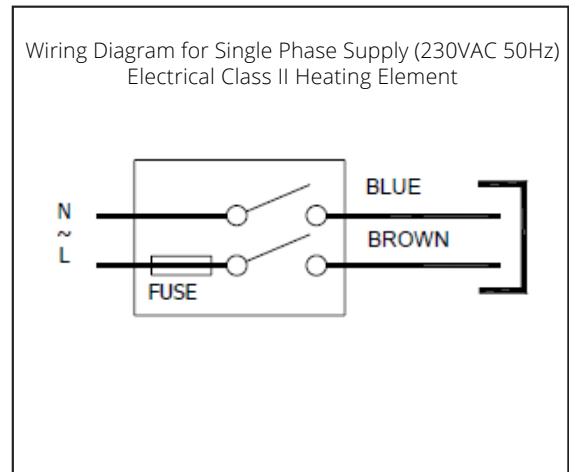
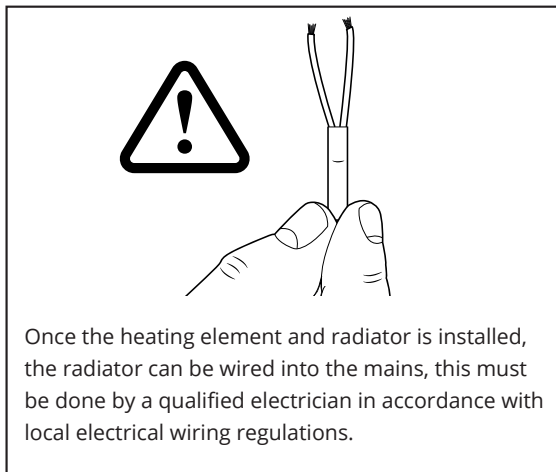

Connecting to WIFI Via Mobile or Tablet

- Search the "Smart Life" APP from Google Play store or Apple Store.
- Ensure your smart phone is connected to your home WIFI network.
- Install the Smart Life APP and follow the instructions to register your account.
- To enter pairing mode, plug in the device and press and hold the  icon on the element for 3 seconds.
- When the icon start flashing, the device is in pairing mode. Follow the steps below to complete the pairing process.
- Add device by pressing the + button at top right corner
- The App will then automatically search for any nearby devices
- Once the device is found tap 'Add' choose your WIFI network and add password, tap 'Next'
- For Android OS you may be asked for additional Bluetooth permissions at this point, please follow the on screen prompts
- The device will begin the connection process and will display on the App after successfully paired.

Element Panel

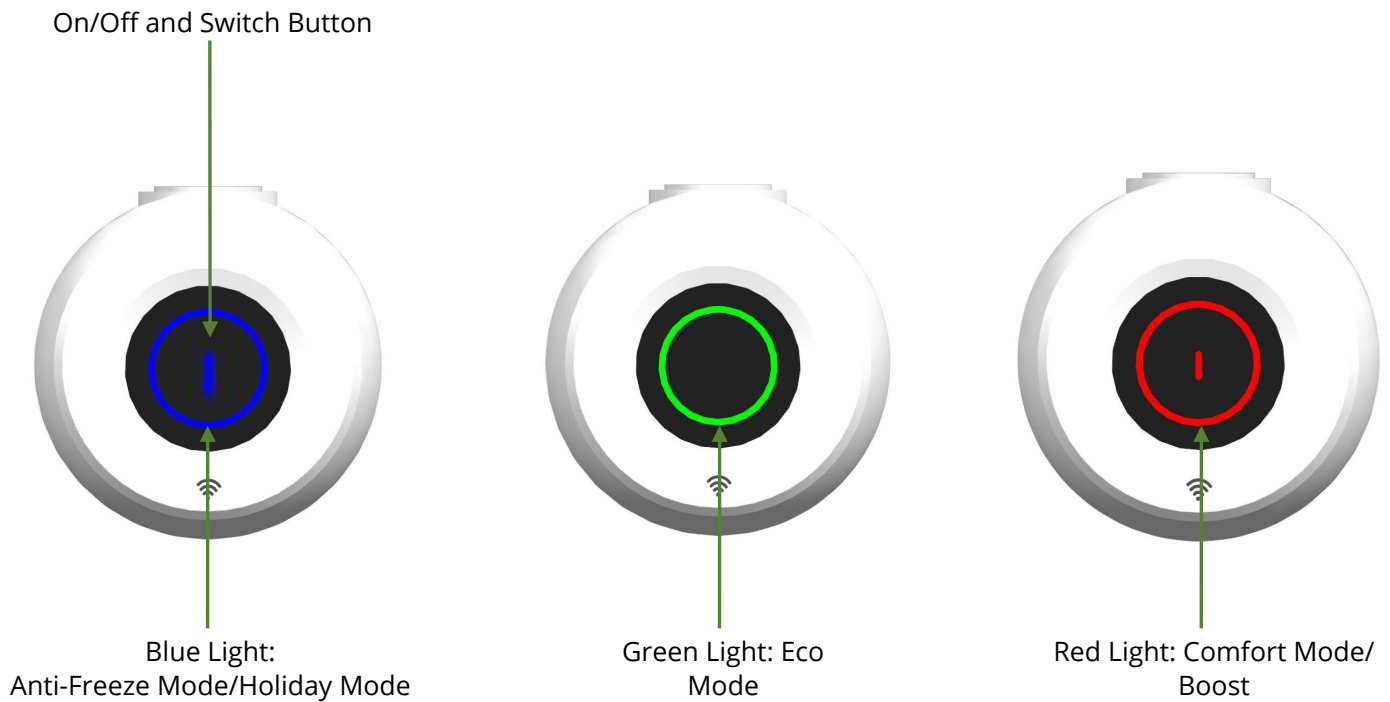

Element Operation

Standby Mode:

Once the controller is powered on, the unit will go into standby mode. Press the centre of the controller to switch ON/OFF.



Heating Mode

Press the icon  to switch the controller on and switch between modes. There are five modes:

- Comfort mode
- Eco mode
- Anti-freeze mode
- Boost mode
- Holiday mode (only available via the App).

Comfort Mode

In this mode, the element controls the room temperature and heats to a constant set temperature. The external thermostat measures the ambient temperature and instructs the element to heat or stop heating according to the temperature set.

- While the device is in standby mode, press the  icon to transition into comfort mode. While in this mode, a red ring will be displayed on the screen. The default set temp is 19°C.
- The set temperature range is 7-30°C and it can be adjusted by using the App.
- The red ring  will pulse while heating, and it will remain steady when the heating stops



Eco Mode

In this mode, the element controls the room temperature and heats to a constant set temperature. The external thermostat measures the ambient temperature and instructs the element to heat or stop heating according to the temperature set.

- Simply tap the center of the screen in comfort mode to switch to Eco mode. While in this mode, a green ring will be displayed on the screen. The default set temp is 15°C.
- The set temperature range is 7-30°C and it can be adjusted by using the App.
- The green ring  will pulse while heating, and it will remain steady when heating stops.



Anti-freeze Mode

If the sensor detects an ambient temperature falling below 7°C, the device will automatically switch on to heat the environment to 7°C and then switch off. In this mode, it prevents the heating medium inside the radiator from freezing and can also maintain a low room temperature.

- You can also tap the center of the screen in Eco mode to activate Anti-freeze mode. While in this mode, a blue ring will be displayed on the screen, indicating that the temperature is set to 7°C, which is not adjustable.
- The blue ring  will pulse while heating, and it will remain steady when heating stops.



Element Operation Cont..

Boost Mode

The device will work constantly for the set hours at maximum performance if the room temperature is under 30°C. After heating for the set hours, it will revert back to previous chosen mode and temperature.

- Press and hold the center of the screen for 5S while in any heating mode to activate the boost mode. While in this mode, a red ring will be displayed on the screen, accompanied by a flashing icon  at the center.
- The boost hour is 3 hours.



Holiday Mode

To avoid having to adjust each radiator individually or add a different schedule, you can simply activate Holiday Mode. This will suspend your schedules and set the energy-saving temperature to 7°C preventing your home from freezing up. Once the holiday setting time ends, it will automatically return to standby mode.

- You can only activate the Holiday mode from the App. While in this mode, a blue ring will be displayed on the screen and the icon  in the center of the screen will flash.
- Holiday time can be adjusted from the App only, the setting range is 1~60 days.



App Operation

Home Overview

You can use the Smartlife App to control multiple devices. All devices are displayed on the home screen with their status.

Possible statuses:

- Online – Heater will respond to app commands.
- Offline – Device is turned off at wall or power switch. It cannot be controlled via the app.

App Interface & Settings

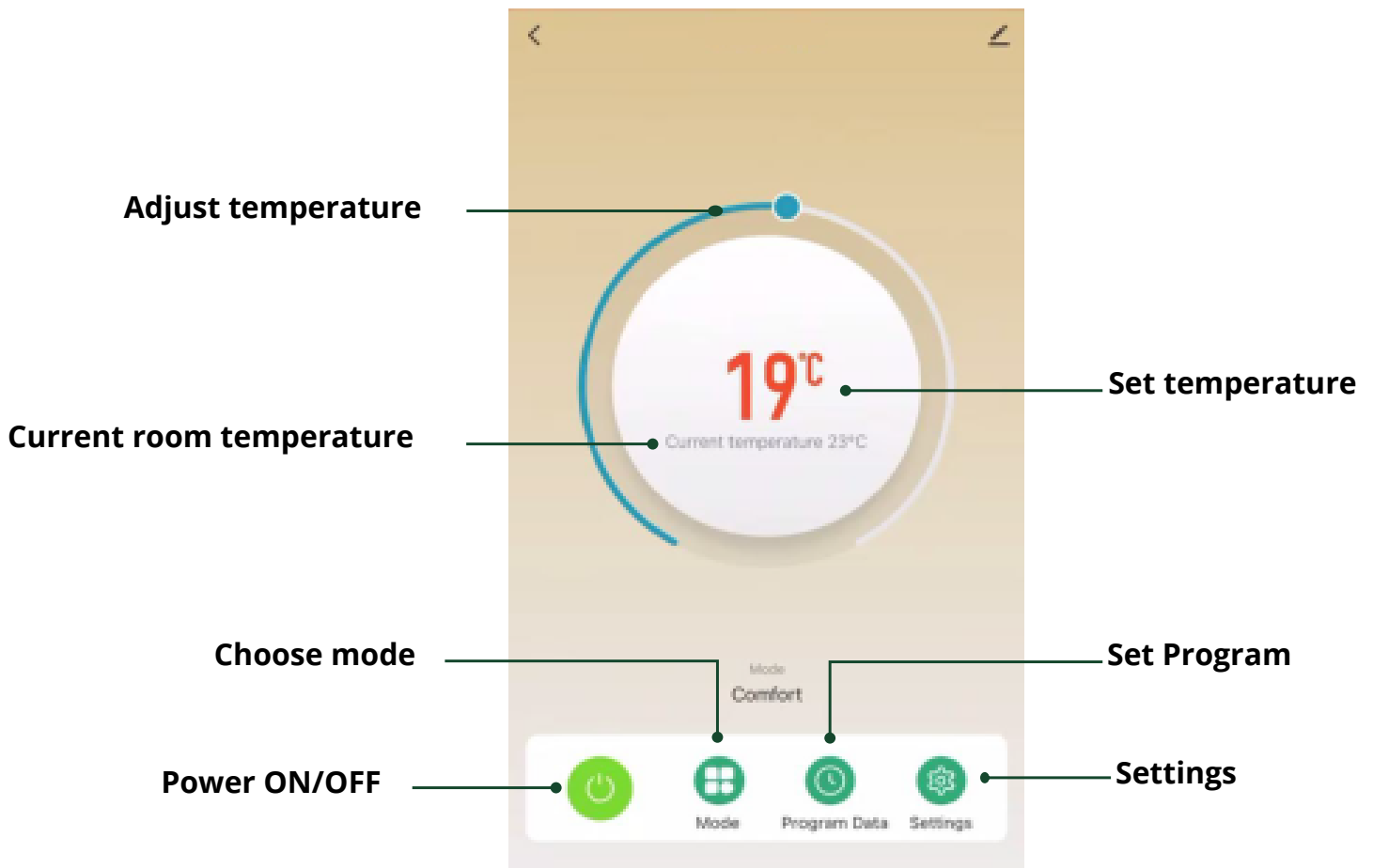

Mode Settings Via The App

Choose Mode

Tap the mode button on the interface to choose mode. The six options correspond to the six modes on the control panel. Boost, Program, and Holiday mode.

Comfort & Eco Mode

In comfort and Eco mode, simply use the sliding dial to set room temp.

Anti-Freeze Mode

In anti-freeze mode, the element will maintain a low room temperature for energy saving or when you are absent from the house.

Boost Mode

If you need a brief period of maximum heating performance, then select the boost mode, which has a duration of 3 hours. During this mode, the element will remain on for the set hours at maximum performance as long as the room temperature is below 30°C. After heating for the setting hours, it will revert back to previous chosen mode and temperature.

Program Mode

Tap the mode button to select the Program and tap the program data icon on the control interface to configure a program.

A program consists of 24 hourly intervals for each day, which you can set to Comfort, Eco or Anti-freeze temperature.

Tap the interval to choose Comfort (yellow bar), Eco (green bar) or Anti-freeze (blue bar). You can drag the start and end times of each mode block to make setting your programming quick and easy.

While in the program mode, the icon  in the center of the screen will light up while the rings will represent different modes

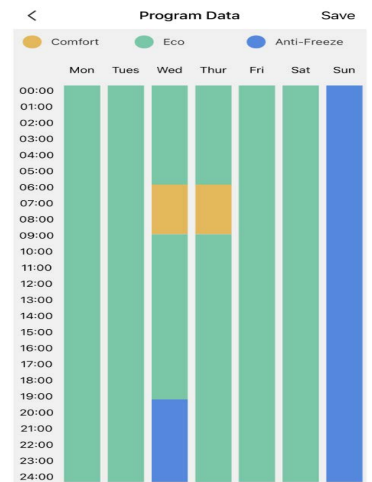
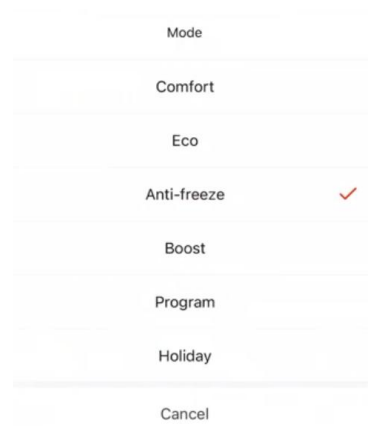

Eco mode



Anti-freeze mode



Comfort mode

Holiday Mode

To avoid having to adjust each radiator individually or add a different schedule, you can simply activate holiday Mode. This will suspend your schedules and set the energy-saving temperature to 7°C preventing your home from freezing up. Once the holiday setting time ends, it will automatically return to standby mode.

Element Settings Via The App

Tap the settings icon to view and adjust the element settings. This menu allows you to configure several settings not available through the control dial. Tap the icon for settings that relate to the element's listing on the app.

Child Lock

Use the toggle switch to lock/unlock the device's display. Once the Child Lock is activated, the color ring of the corresponding mode will be fixed on the screen, any attempt to touch the screen will have no effect.

To unlocking manually: Disconnect the power supply and reconnect it.

Temperature Compensation

You can adjust the temperature compensation in steps of 1°C, from -10°C to 10°C. The default temperature compensation is 0°C. This setting allows users to adjust for any discrepancy between the average room temperature and the temperature sensed by the elements internal thermostat.

For instance, if the temperature in the room is 18°C, but the thermostat senses 16°C, a compensation factor of +2°C will offset the difference. The accuracy of the element's temperature reading can be affected if the unit is mounted such that the sensor is positioned in a hot or cold spot, e.g., near hot water pipes or in a draughty doorway. The sensor is the short probe on the reverse of the control dial.

Open window detection

There are three options for the open window detection function: OFF, 60 minutes and 90 minutes.

Open window detection is an energy-saving feature designed to cut power to the unit if a window is opened. If the device detects a sudden drop in temperature (2°C or more within 5 minutes), it will switch to anti-freeze the temperature (fixed at 7°C) for 60/90 minutes to prevent energy wastage as heat escapes through the window. It will revert back to the previous mode after 60/90 minutes. If the temperature drops by 2°C within 5 minutes again, the device will continue to switch to the anti-freeze temperature (fixed 7°C), then cycle through.



Element Settings Cont...

Holiday Time Setting

Holiday time can be adjusted via the App only when in the holiday mode from the control interface, the setting range is 1~60 days.

Trouble Shooting

- Make sure both the element and your smart device are in range of your router.
- Make sure you complete the connection process in 2 minutes. If the APP can be not connected, you must begin the process again.
- Ensure your router has a strong internet connection.
- Ensure WiFi and Bluetooth are enabled on your smart device.
- Make sure the app has registered successfully.
- Make sure your smart device is connected to the same WiFi network as that to which you are attempting to connect the element.
- Ensure you are connected to a 2.4G WiFi band. See instructions within the app if you are currently connected to a 5G band.
- Check any local restrictions on your WiFi. WiFi networks in public places such as hotels and airports may require extra identification steps.

Error	Action
The thermostat sensor detects a temperature abnormality	The red bar remains steady



Technical Information

Voltage	220-240V AC / 50Hz
Wattage	400-2000W
Frost protection	7°C
Temperature setting	15-30°C
IP rating	IPX4
Timer mode	Boost 3 hours
Appliance class	Class II
Thread size	G ½ "
Application	This element is not suitable for dry heating. It must be submerged in liquid (either in a liquid-filled electric-only installation, or as part of a dual-fuel installation).

Your Guarantee

To find the specific guarantee for your products please refer to the website.

The guarantee starts from the date of purchase.

The guarantee covers you against issues caused as a result of manufacturing related issues, it does not apply to issues that are found to be a result of poor installation.

Labour costs for for installation of the products are not covered under this warranty.

Aftercare

Clean any marks with a soft, dry or damp cloth, for stubborn stains please clean with mild soapy water and dry with a soft cloth. DO NOT use abrasive or acidic cleaners.

If you are unsure, please contact us first.

Recycling and Disposal

The **Waste Electrical and Electronic Equipment Directive (WEEE Directive)** is the **European Community directive 2012/19/EU** on **Waste Electrical and Electronic Equipment (WEEE)** which, together with the **RoHS Directive 2002/95/EC**, became European Law in February 2003

The WEEE directive aims to reduce the amount of electrical equipment being produced and to encourage everyone to reuse, recycle and recover it.

In support of these guidelines and for environmental safety, do not dispose of any electrical equipment including those marked with the below symbols

When replacing old electrical devices with new ones the retailer is legally obligated to take back your old items for disposal free of charge. You can also recycle your old electrical devices free of charge at your local recycling centre. Please contact your local council for more information.

Please recycle the packaging in accordance with your local government regulations on waste handling and follow the same advice at the end of the products life.

Product - Steel.

Packaging - Cardboard, plastic, steel.

Contact us

Unit 1 & 2 Dawson Ct

Burnley

Lancashire

BB11 5UB